



**Let's swim
together!**

COMERCIAL GROUP

The world leader in customised equipment and swimsuits

We proudly cooperate with the leading Global Swim, Triathlon Brands, Federations and International Organisations.



We provide the means for you and your team to have customised products without worrying about big minimum quantity orders and with the best quality.



Design Service

Not ready to submit your own design? Our design team will help your ideas become a reality.



Love Our Clients

We'll be happy to help you during all the process. Contact us by email and phone.



Powerful & Flexible

We can adapt to your needs. From the simplest to the most complicated designs.



Premium Support

We're happy to be there for you. We have the experience from working with the most important brands.

INDEX

SWIM CAPS

- 4 Cap printing options
- 5 Print size and packaging
- 6 Latex
- 7 Silicone jr
- 8 Silicone sr
- 9 Silicone suede
- 10 Silicone recycled
- 11 Silicone ultralight
- 12 Silicone long hair
- 13 Silicone volume standard/suede
- 14 Silicone competition FVC8
- 15 Silicone competition FVC6
- 16 Elastane round comfort jr
- 17 Elastane round comfort sr
- 18 Printed caps jr
- 20 PU coated
- 21 Polyester

SWIM GOGGLES

- 22 Colmar jr
- 23 Marni jr
- 24 Marni jr recycled
- 25 Aquatix
- 26 Colmar sr
- 27 Marni sr
- 28 Marni sr recycled
- 29 Dual / Dual mirror

POOL SHOES

- 30 Adi / Raway
- 31 Flip flops
- 32 Neosocks

SWIM ACCESSORIES

- 33 Microfibre towels
- 34 Nose protection
- 35 Ear protection
- 36 Slide fins
- 38 Recycled fins
- 39 Black fins
- 40 Colourful fins
- 41 Open fins
- 42 Fin pro
- 43 Frontal snorkel
- 44 Diving set
- 45 Hand paddles
- 46 Team hand paddles
- 47 Backpacks
- 48 Dry bags
- 49 Inflatable swim buoys
- 50 Boards
- 51 Pull buoys

SUBLIMATION

- 52 Sublimated swimwear
- 53 Sublimation process
- 54 Woman and girl patterns
- 55 Man and boy patterns
- 56 Waterpolo patterns
- 57 Sublimated cap and towel
- 58 Poncho, surf and sun top
- 59 Bindings/Linings/Solids availables
- 60 Size guide
- 61 Country size table

TEAM LINE

- 62 Sublimated team line
- 64 T-shirt
- 65 Polos
- 66 Sweatshirts / Jackets
- 67 Pants

DELIVERY SERVICE

- 68 Delivery service(caps and sublimated swimwear)

CAP PRINTING OPTIONS

Positional print

We print small logos, medium designs, large designs, and all-over prints. We can print your design on one or both sides of the cap, on the front and the back. Up to 6 colours per side.



Names and numbers

For your team, count on our Names and Numbers service, it's everything you need. Get the swimmer's name or number printed on each side along with your logos or flags.



Photographic print

Available for all our flat silicone caps, in standard or suede finishes, for both adults and children.



Ceramic print

Get the best of our high-quality printing techniques with our exclusive ceramic print finish on suede caps. Matte cap, glossy print.



Digital print

Don't miss out on glitter inks, tone-on-tone printing, and high-definition digital printing.



Hydro Foil

Hydro foil print is an impressive technique that takes design to the next level with its shiny, metallic finish, transforming any piece into something truly special and high-impact.



PRINT SIZE & PACKAGING

PRINT SIZE

SMALL LOGO: Max. 40x50 mm.

MEDIUM LOGO: Prints till 3cm to the cap edges.

BIG LOGO: Prints till 0,5 cm to the cap edges.

ALL OVER PRINT: Reaching cap edges.



CUSTOMISABLE PACKAGING

STANDARD SEALED BAG



23x26 cm
NEUTRAL STANDARD CAP BAG
WITH EUROHOLE

OTHER PACKAGING OPTIONS (Check minimums)



12,5x29 cm
OPP BAG
PP (POLIPROPILENE)



12x25 cm
MINI GRIP
PE (POLIETILENE)



24x23 cm
BUTTON BAG



13x24 cm
ZIPPER BAG



24x23 cm
SHAPE BAG



12x13,5 cm
MINI GRIP
PE (POLIETILENE)

LATEX

A staple for pool workouts, this latex cap is the go-to for training and recreational swimmers. Its scalloped bottom edge resists tearing, offers a comfortable anti-roll fit, and provides excellent UV protection.



70 SKY BLUE 71 ROYAL BLUE 72 NAVY BLUE 60 GREEN



21 YELLOW 30 ORANGE 40 RED 50 PINK



85 SILVER 10 WHITE 90 BLACK

ADULT **REF** G1002

Size 24,5 X 18,8 CM

100% Latex

30 g weight

Non-slip inside pattern

Maximum elasticity and recovery

Assortment of 11 colours available for immediate delivery

Other colours on request

CUSTOMISABLE

Highest quality screen printing

Customisable front, sides and back

Up to 6 colours per side

SILICONE JUNIOR

It protects your hair, reduces drag, and helps you glide through the water like a dolphin. Flexible and comfortable, it's perfect for little champions who want to swim fast and have a blast. Get ready to compete!



70 SKY BLUE

71 ROYAL BLUE

72 NAVY BLUE

61 MED GREEN



21 YELLOW

30 ORANGE

40 RED

50 PINK



90 BLACK

10 WHITE

JUNIOR REF G2001JR

Size 20,5 X 17,2 CM

100% hypoallergenic silicone

Non-slip inside pattern

Maximum elasticity and recovery

Assortment of 10 colours available for immediate delivery

Other colours on request

CUSTOMISABLE

Highest quality screen printing

Two sides

Front and back

Names and numbers

Up to 6 colours per side



SILICONE ADULT

It protects hair from water and reduces drag while swimming. Made of flexible silicone, it fits comfortably, creating a smooth surface that enhances speed and performance. Ideal for training and competition.

Premium: exclusive model with a purity certificate, the only 100% silicone cap you'll find on the market.

Classic: our standard cap, perfect for daily use.

Essential: the most affordable and common model on the market, lighter (46g), ideal for occasional swimmers.



70 SKY BLUE 71 ROYAL BLUE 72 NAVY BLUE 61 MED GREEN



60 FL GREEN 20 FL YELLOW 21 YELLOW 30 ORANGE



40 RED 43 BORDEAUX 81 VIOLET 50 PINK



90 BLACK 10 WHITE 86 GOLD 85 SILVER



ADULT REF G2001SR

Size 22,5 X 19,2 CM

100% hypoallergenic silicone

Non-slip inside pattern

Maximum elasticity and recovery

Assortment of 16 colours available for immediate delivery

Other colours on request

CUSTOMISABLE

Highest quality screen printing

Two sides

Front and back

Names and numbers

Up to 6 colours per side

SILICONE SUEDE

All the features of the Premium silicone cap can be found in this model, with one special detail: the **suede finish**. Enjoy the beautiful **ceramic prints**, shiny designs that stand out against the suede cap.

Premium: exclusive model with a purity certificate, the only 100% silicone cap you'll find on the market.

Classic: our standard cap, perfect for daily use.

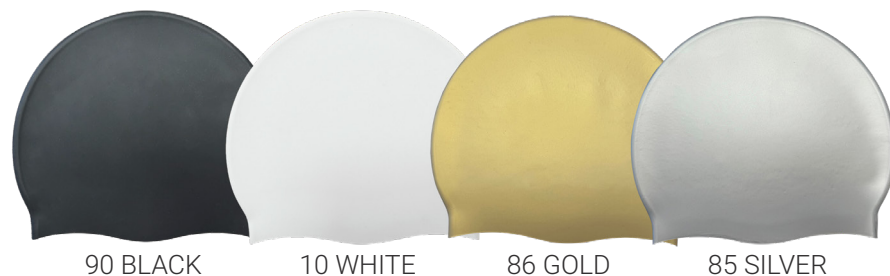

ADULT REF **G2002**

Size 22,5 X 19,2 CM

100% hypoallergenic silicone

Special **SUEDE surface treatment**

Non-slip inside pattern

Maximum elasticity and recovery

Assortment of 16 colours available for immediate delivery and 10 for junior size

Other colours on request

CUSTOMISABLE

Highest quality screen printing

Unique **ceramic print**. Excellent contrast and definition

Two sides

Front and back

Names and numbers

Up to 6 colours per side

SILICONE RECYCLED

Advantages of a recycled swimming cap:

1. **Eco-friendly** and sustainable: reduces waste and promotes responsible consumption.
2. **Quality**: retains the fit and durability of conventional caps.
3. **Lower carbon footprint**: reduces pollution by using recycled materials.
4. Supports innovation and **sustainability**.
5. Enjoy the beautiful **ceramic prints**, shiny designs that stand out against the suede cap.



71 ROYAL BLUE

60 FL GREEN

50 PINK

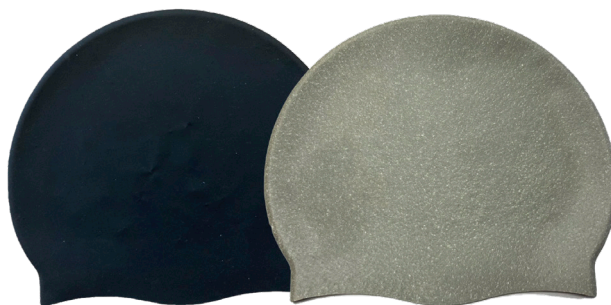

90 BLACK

10 GREY



**Made from
RECYCLED
SILICONE**

ADULT REF **G2052**

Size 22,5 X 19,2 CM

100% hypoallergenic silicone

50% RECYCLED SILICONE

Special SUEDE surface treatment

Maximum elasticity and recovery

Assortment of 5 colours available for immediate delivery

Other colours on request

CUSTOMISABLE

Highest quality screen printing

Unique ceramic print. Excellent contrast and definition

Two sides

Front and back

Names and numbers

Up to 6 colours per sideUp to 6 colours per side

SILICONE ULTRALIGHT

The Ultralight cap is exceptionally comfortable due to its lighter weight, creating less tension and making it easy to put on. It maintains all silicone cap benefits. Ideal for long training sessions or competitions.

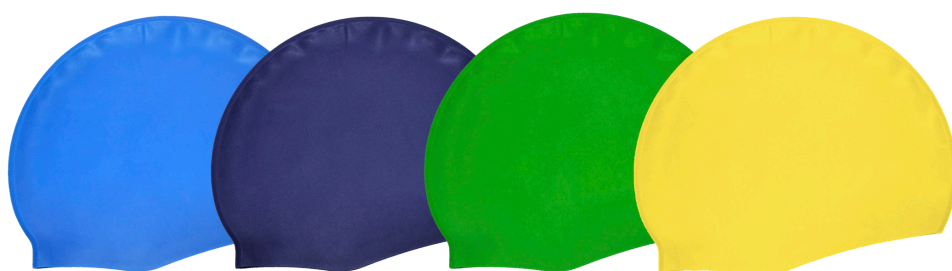

71 ROYAL BLUE

72 NAVY BLUE

61 MED GREEN

21 YELLOW



40 RED

50 PINK

10 WHITE

90 BLACK

85 SILVER

ADULT **REF** G2003

Size 22,5 X 19,2 CM

100% hypoallergenic silicone

Ultralight cap, 33 grams only

Non-slip inside pattern

Maximum elasticity and recovery

Assortment of 9 colours available for immediate delivery

Other colours on request

CUSTOMISABLE

Highest quality screen printing

Two sides

Front and back

Names and numbers

Up to 6 colours per side

SILICONE LONG HAIR

The silicone cap for long hair provides extra space to comfortably and elastically accommodate the hair. It prevents pulling when putting it on or taking it off, is water-resistant, and protects against chlorine.



ADULT REF **G2004**

100% hypoallergenic silicone
[Special shape for long hair with extra space](#)
Non-slip inside pattern
New special compound to allow more elasticity and recovery
Assortment of 6 colours available for immediate delivery
Other colours on request

CUSTOMISABLE

Highest quality screen printing
Two sides
Front and back
Names and numbers
Up to 6 colours per side Up to 6 colours per side

SILICONE VOLUME

The volume cap is specifically designed to provide a comfortable and secure fit without creating wrinkles. Made from high-quality silicone, its structure allows for ample interior space.

Available in standard or suede finish.

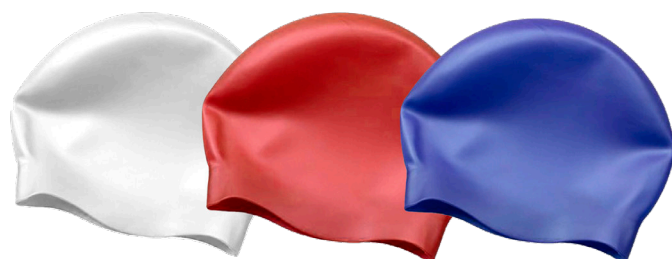

10 WHITE

40 RED

71 ROYAL BLUE

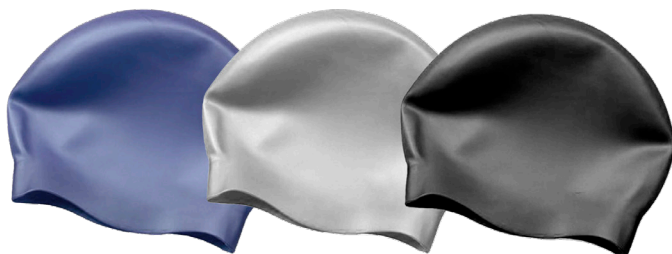

72 NAVY BLUE

85 SILVER

90 BLACK



10 WHITE
SUEDE

21 YELLOW
SUEDE

85 SILVER
SUEDE

90 BLACK
SUEDE

VOLUME STANDARD REF **G2006**
VOLUME SUEDE REF **G2007**

100% hypoallergenic silicone
[Volume dome-shaped, wrinkle free](#)
Ergonomic shape that fits perfectly to the head
Non-slip inside pattern
Maximum elasticity and recovery
Assortment of 6 colours in standard silicone and 4 in silicone surface suede. Available for immediate delivery
Other colours on request

CUSTOMISABLE
Highest quality screen printing
Two sides
Front and back
Names and numbers
Up to 6 colours per side

SILICONE FVC8

The FVC8 cap is the classic competition cap. With completely rounded and seamless shape, it becomes the most hydrodynamic cap, perfect for being the fastest in the pool. It is perfect for competition, it is not recommended for long training sessions.

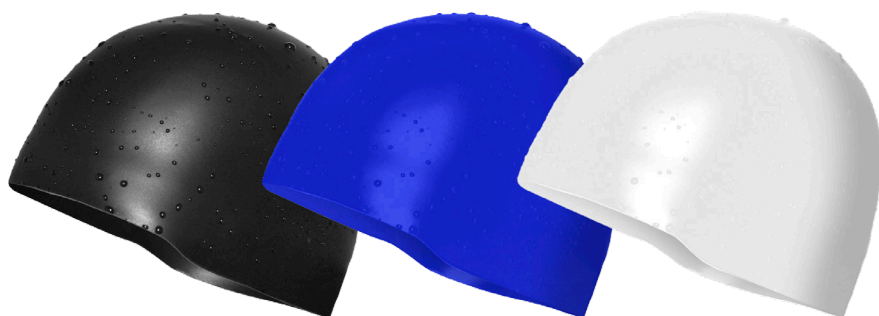

90 BLACK
M/L

71 ROYAL BLUE
M/L

10 WHITE
M/L



21 YELLOW
L

50 PINK
L

40 RED
M/L



ADULT REF **G2014**

100% hypoallergenic [suede silicone](#)

Full volume swim cap ideal for high competition specially designed to avoid wrinkles

Assortment of 6 colours for immediate delivery

Available in two sizes depending on colour

Other colours on request

CUSTOMISABLE

Highest quality screen printing

Two sides

Front and back

Names and numbers

Up to 6 colours per side

SILICONE FVC6

The FVC6 cap is presented as a novelty in the competition category. It is a more flexible and comfortable than the FVC8. It comfortably fits any size and meets the highest quality standards. Perfect for competition thanks to its rounded shape seamless that provide hydrodynamics.



10 WHITE

90 BLACK

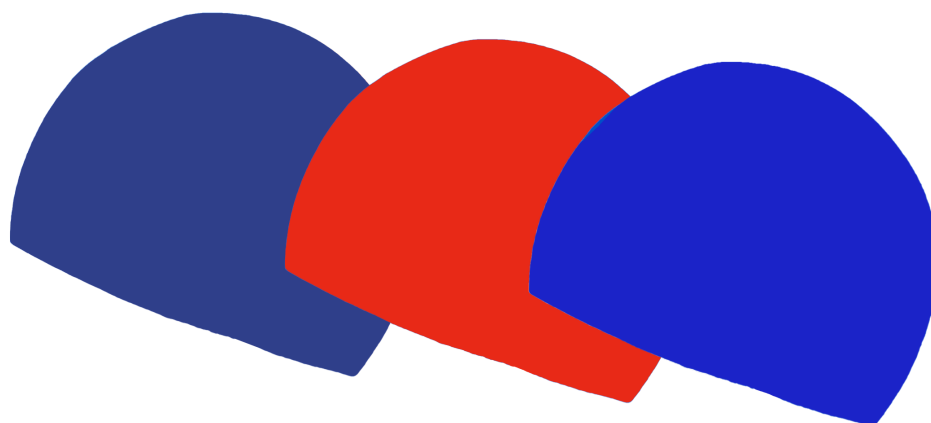

72 NAVY BLUE

40 RED

71 ROYAL BLUE

ADULT REF **G2075**

100% hypoallergenic [suede silicone](#)

Full volume swim cap ideal for high competition specially designed to avoid wrinkles

Assortment of 2 colours for immediate delivery

Other colours on request

CUSTOMISABLE

Highest quality screen printing

Two sides

Front and back

Names and numbers

Up to 6 colours per side

ELASTANE JUNIOR

Made from flexible, soft elastane, this cap is comfortable, easy to put on, and fits well without feeling too tight. Though not fully waterproof like silicone or latex, elastane is lightweight, breathable, and ventilated, making it ideal for training or those seeking extra comfort.

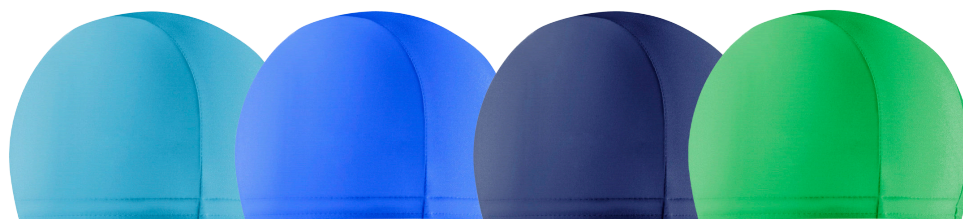

70 SKY BLUE

71 ROYAL BLUE

72 NAVY BLUE

61 MED GREEN



21 YELLOW

30 ORANGE

40 RED

50 PINK

10 WHITE

JUNIOR **REF** G3001JR

85% Polyester / 15% Elastane

Size: 19,12 x 17 cm.

Ergonomic fit with wide elastic band

Maximum elasticity and recovery

Assortment of 9 colours available for immediate delivery

CUSTOMISABLE

Highest quality screen printing

Two sides

Front and back

ELASTANE ROUND COMFORT

Made from flexible, soft elastane, this cap is comfortable, easy to put on, and fits well without feeling too tight. Though not fully waterproof like silicone or latex, elastane is lightweight, breathable, and ventilated, making it ideal for training or those seeking extra comfort.



70 SKY BLUE

71 ROYAL BLUE

72 NAVY BLUE

61 MED GREEN



21 YELLOW

30 ORANGE

40 RED

50 PINK

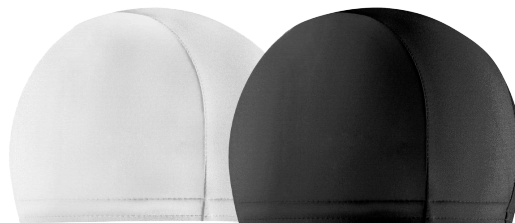

10 WHITE

90 BLACK

ADULT REF **G3001SR**

85% Polyester / 15% Elastane

Size: 20,5 x19,5 cm.

Ergonomic fit with wide elastic band

Maximum elasticity and recovery

Assortment of 10 colours available for immediate delivery

CUSTOMISABLE

Highest quality screen printing

Two sides

Front and back

PRINTED CAPS JUNIOR

Printed swim caps are the best for little swimmers! This collection features tons of fun designs, from bright colours to their favorite characters. They're easy to put on and take off, so no fuss when getting in or out of the water. Fun in the pool is guaranteed!



FLAMINGO
C3PRIFLAMJR



HADA
C3PRIHADAJR



UNICORN
C3PRIUNIJR



MONSTER
C3PRIMOORJR



TIBU
C3PRITIBUJR



PIRATA
C3PRIPIRAJR



TRUCK
C3PRITRUCKJR



GRAF
C3PRIGRAFJR



ICE CREAM
C3PRIICECREAMJR



ARIEL
C3PRIARIELJR



SPACE
C3PRISPACEJR



YOGUI
C3PRIYOGUIJR

JUNIOR

85% Polyester / 15% Elastane
Ergonomic fit with wide elastic band
Maximum elasticity and recovery
Junior designs available for immediate delivery



PACKAGING
OPP BAG

PRINTED CAPS JUNIOR

Printed swim caps are the best for little swimmers! This collection features tons of fun designs, from bright colours to their favorite characters. They're easy to put on and take off, so no fuss when getting in or out of the water. Fun in the pool is guaranteed!and bicolour options.



LOLA
C3PRILOLAJR



MAYA
C3PRIMAYAJR



SIREN
C3PRISIREJR



PAZ
C3PRIPAZJR



FAIRY
G3077FAIRYJR



PRINCESS
G3077PRINCESSJR



GAME OVER
G306971JR



PLAY
G3077PLAYJR

JUNIOR

85% Polyester / 15% Elastane
Ergonomic fit with wide elastic band
Maximum elasticity and recovery
Junior designs available for immediate delivery



PACKAGING
OPP BAG

COATED CAPS

Polyurethane swim caps blend the softness of fabric with silicone's water resistance. Made from fabric coated in polyurethane, they're flexible, comfortable, and easy to put on without pulling hair.



72 NAVY BLUE

85 SILVER

71 ROYAL BLUE



50 PINK

90 BLACK

PU ADULT REF **G3002**

85% Polyester / 15% Elastane + PU coated
Ergonomic shaped cap with wide elastic band
Maximum elasticity and recovery
Assortment of 5 colours available for immediate delivery

CUSTOMISABLE

Highest quality screen printing
Two sides
Front and back

POLYESTER

Polyester swim caps are comfortable, durable, and easy to put on. While not waterproof, they provide good protection against chlorine and UV rays, making them ideal for recreational swimmers. Lightweight and breathable, they are available in solid and bicolour options.



70 SKY BLUE 71 ROYAL BLUE 72 NAVY BLUE 61 MED GREEN



21 YELLOW 40 RED 90 BLACK



70 SKY BLUE 71 ROYAL BLUE 72 NAVY BLUE



61 MED GREEN 40 RED 90 BLACK

MONOCOLOUR REF **G4001**
BICOLOUR REF **G4002**

100% Polyester
Very light and comfortable
Available in adult size
Assortment of 7 solid colours and 6 bicolour with a white central band
Other colours on request
Available for immediate delivery

CUSTOMISABLE

Highest quality screen printing
Two sides
Front and back

COLMAR JR

A basic yet powerful swim goggle with a single silicone strap and coloured flat PC lenses. Featuring Anti-Fog, UV protection technology, the scratch-resistant lenses are fully sealed, offering solid eye protection and clear visibility while swimming.



50 PINK
SW1
QTY/PACK: 5



71 BLUE
SW1
QTY/PACK: 5



20 YELLOW
SW0
QTY/PACK: 2

COLMAR JR **REF** A100297JR

LENSES

ISO category lenses.

Polycarbonate flat lenses.

UV protection (protection from ultraviolet rays).

Anti-Scratch treatment (protection against minor scratches).

Anti-Fog treatment.

ONE PIECE GASKET

TPE gasket in one piece. The high flexibility of the gasket will fit comfortably to your face.

HEAD STRAP

Single silicone head strap.

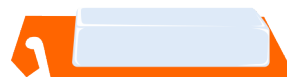

PACKAGING
SLIDE BLISTER



INNER BOX: 12 PCS
EXPORT CARTON: 144 PCS

MARNI JR

A colourful and fun swim goggle. Its easy-adjust clip provides a quick way to fasten the straps for everyone.



70 BLUE
SW1
QTY/PACK: 3



90 BLACK
SW2
QTY/PACK: 2



50 FUCHSIA
SW1
QTY/PACK: 3



60 GREEN
SW0
QTY/PACK: 2



10 YELLOW
SW0
QTY/PACK: 2

MARNI JR REF **A100197JR**

LENSES

ISO category lenses.
Polycarbonate flat lenses.
UV protection (protection from ultraviolet rays).
Anti-Scratch treatment (protection against minor scratches).
Anti-Fog treatment.

ONE PIECE GASKET

Silicone gasket in one piece.
The high flexibility of the gasket will fit comfortably to your face.

HEAD STRAP

Double silicone head strap.

EASY-ADJUST CLIP

Easily adjust the size by pulling the end of the straps backwards.
To release, simply press the side clip.

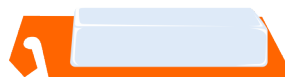

PACKAGING
SLIDE BLISTER

INNER BOX: 12 PCS
EXPORT CARTON: 144 PCS

MARNI JR RECYCLED

Advantages of a recycled swimming goggle:

1. **Sustainability:** Reduces waste and protects the environment.
2. **Quality:** Same features as Marni JR goggles.
3. **Unique style:** Unique colour and texture.
4. Environmental awareness: **Promotes recycling.**
5. **Durability:** Resilience and good value for money.



MARNI JR RECYCLED **REF** A1135JR

LENSES

ISO category lenses.
Polycarbonate flat lenses.
UV protection (protection from ultraviolet rays).
Anti-Scratch treatment (protection against minor scratches).
Anti-Fog treatment.

ONE PIECE GASKET

One-piece **recycled** silicone gasket.
The high flexibility of the gasket will fit comfortably to your face.

HEAD STRAP

Double silicone head strap.

EASY-ADJUST CLIP

Easily adjust the size by pulling the end of the straps backwards
To release, simply press the side clip.



PACKAGING
SLIDE BLISTER



INNER BOX: 12 PCS
EXPORT CARTON: 144 PCS

AQUATIX SR

Our basic training swim goggles offer comfort and performance at an excellent price. They are ideal for swimmers of all levels seeking reliability and durability in every training session. A must-have basic for your swim bag!



AQUATIX SR REF **A1137SR**

LENSES

Polycarbonate flat lenses.
UV protection (protection from ultraviolet rays).
Anti-Scratch treatment (protection against minor scratches).
Anti-Fog treatment.

ONE PIECE GASKET

TPE gasket in one piece. The high flexibility of the gasket will fit comfortably to your face.

HEAD STRAP

Single silicone head strap.

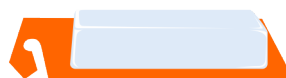

PACKAGING
SLIDE BLISTER



INNER BOX: 12 PCS
EXPORT CARTON: 144 PCS

COLMAR SR

A basic yet powerful swim goggle with a single silicone strap and coloured flat PC lenses. Featuring Anti-Fog, UV protection technology, the scratch-resistant lenses are fully sealed, offering solid eye protection and clear visibility while swimming.



71 BLUE
SW1
QTY/PACK: 4



90 SMOKE
SW2
QTY/PACK: 4



50 PINK
SW1
QTY/PACK: 2



20 YELLOW
SW0
QTY/PACK: 2

COLMAR JR **REF** A100297SR

LENSES

ISO category lenses.
Polycarbonate flat lenses.
UV protection (protection from ultraviolet rays).
Anti-Scratch treatment (protection against minor scratches).
Anti-Fog treatment.

ONE PIECE GASKET

TPE gasket in one piece. The high flexibility of the gasket will fit comfortably to your face.

HEAD STRAP

Double silicone head strap.



PACKAGING
SLIDE BLISTER

INNER BOX: 12 PCS
EXPORT CARTON: 144 PCS

MARNI SR

Featuring durable, hypoallergenic silicone gaskets for a comfortable, watertight seal, these goggles maintain their shape over time. With a secure release button for easy strap adjustment and a one-piece design that fits various face shapes, they're ideal for training and recreation.



TRANS/BLACK
SW0
QTY/PACK: 4



SMOKE/WHITE
SW2
QTY/PACK: 2



AMBER/BLACK
SW1
QTY/PACK: 2



BLUE
SW1
QTY/PACK: 4

MARNI SR  **A100197SR**

LENSES

ISO category lenses.
Polycarbonate flat lenses.
UV protection (protection from ultraviolet rays).
Anti-Scratch treatment (protection against minor scratches).
Anti-Fog treatment.

ONE PIECE GASKET

One-piece silicone gasket.
The high flexibility of the gasket will fit comfortably to your face.

HEAD STRAP

Double silicone head strap.

EASY-ADJUST CLIP

Easily adjust the size by pulling the end of the straps backwards.
To release, simply press the side clip.



ANTI FOG



ANTI SCRATCH



EASY ADJUST



ONE PIECE



UV PROTECT

PACKAGING
SLIDE BLISTER

INNER BOX: 12 PCS
EXPORT CARTON: 144 PCS

MARNI SR RECYCLED

Advantages of a recycled swimming goggle:

1. **Sustainability:** Reduces waste and protects the environment.
2. **Quality:** Same features as Marni JR goggles.
3. **Unique style:** Unique colour and texture.
4. Environmental awareness: **Promotes recycling.**
5. **Durability:** Resilience and good value for money.



71 BLUE
SW0

MARNI SR RECYCLED REF **A1136SR**

LENSES

ISO category lenses.
Polycarbonate flat lenses.
UV protection (protection from ultraviolet rays).
Anti-Scratch treatment (protection against minor scratches).
Anti-Fog treatment.

ONE PIECE GASKET

One-piece **recycled** silicone gasket.
The high flexibility of the gasket will fit comfortably to your face.

HEAD STRAP

Double silicone head strap.

EASY-ADJUST CLIP

Easily adjust the size by pulling the end of the straps backwards.
To release, simply press the side clip.



PACKAGING
SLIDE BLISTER



INNER BOX: 12 PCS
EXPORT CARTON: 144 PCS

DUAL & DUAL MIRROR

Simple, ergonomic and low profile race goggles with TPE injection gaskets. Self assembly goggle. Available in colored lens and mirror lens.



71 BLUE



90 SMOKE



10 CLEAR



90 SILVER MIRROR

DUAL REF A1006
DUAL MIRROR REF A1006

LENSES

Low profile, hard frame design.

Polycarbonate flat lenses.

180 degree vision.

UV protection (protection from ultraviolet rays).

Anti-Scratch treatment (protection against minor scratches).

Anti-Fog treatment.

NOSE BRIDGE

Adjustable nose bridge by twisting the cord.

Additional silicone nose piece included.

HEAD STRAP

Adjustable silicone head strap.



ANTIFOG



ANTISCRATCH



UVPROTECT

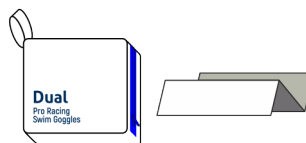

PACKAGING
ZIPPER POUCH +
LEAFLET

INNER BOX: 12 PCS
EXPORT CARTON: 144 PCS

POOL SHOES

ADI POOL SHOES

ADI ADULT **REF** A40129

Comfortable and lightweight pool shoe.

EU SIZES

36 – 40
41, 45

MATERIALS

Synthetic materials.
EVA flat sole.
Cushioned textile upper.

CUSTOMISABLE



90 BLACK

RAWAY POOL SHOES

RAWAY JUNIOR **REF** A4029
RAWAY ADULT **REF** A4028

Comfortable and lightweight pool shoe.

EU SIZES

30 – 35
36 – 40
41 – 45

MATERIALS

100% EVA.
Monoblock.



72 NAVY BLUE



PACKAGING
OPP BAG



EXPORT CARTON: 20 PAIRS

FLIP FLOPS

Flip flops are lightweight and comfortable footwear, ideal for aquatic environments. They are water-resistant, non-slip, easy to clean, and very portable, making them perfect for wearing around the pool or at the beach. Available in a wide variety of colours.



FLIP FLOP **REF** A4042

Lightweight and comfortable ideal as a beach or pool shoe.

EU SIZES

36 – 45

MATERIALS

Sole: EVA.
V-upper: PVC.

CUSTOMISABLE



LIGHTWEIGHT



SOLEGRIP



WATERDRAIN



PACKAGING
OPP BAG



EXPORT CARTON: 20 PAIRS

NEOSOCKS

Pool socks have a non-slip sole that enhances grip on wet surfaces, reducing the risk of slips. Wearing pool socks can help keep feet clean and protected from germs or bacteria present in public areas. They are lightweight and easy to put on and take off.

For indoor pool use only.



50 PINK



71 ROYAL BLUE

NEOSOCK JUNIOR REF A1200
NEOSOCK ADULT REF A1200

Great comfort and secure fit.
Anti-slippery outsole.
Anti-fungic.

PINK EU SIZES

22/23 – 34/35
36/37 – 40/41

BLUE EU SIZES

22/23 – 34/35
36/37 – 44/45

MATERIALS

Neoprene fabric.
Reinforced TPR anti-slip sole.
Polyamide / Elastane.

CUSTOMISABLE



LIGHTWEIGHT



SOLEGRIP



PACKAGING
OPP BAG



EXPORT CARTON: 100 PAIRS

MICROFIBRE TOWELS

Microfibre towels are ideal for swimming or going to the gym thanks to their quick-drying and high absorption capacity, allowing for efficient drying without becoming soaked. Their compact and lightweight design makes them easy to carry in a bag, taking up minimal space and adding hardly any extra weight.



50 PINK
QTY/PACK: 10



70 SKY BLUE
QTY/PACK: 10



72 NAVY BLUE
QTY/PACK: 10

LARGE TOWEL REF **A5001L**

SMALL TOWEL REF **A5001S**

88% Polyester / 12% Polyamide.
Other colours on request.

SIZE

Large: 80 x 130 cm.
Small: 45 x 70 cm (only in navy blue).

CUSTOMISABLE

Print your logo.



PACKAGING
OPP BAG

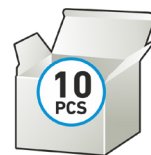

INNER BOX: 10 PCS
EXPORT CARTON: 20 PAIRS

NOSE PROTECTION

Nose clips for swimming prevent water from entering the nose, allowing better control of breathing, protecting against chlorine irritation, and facilitating technical training by allowing swimmers to focus on technique.

CLASSIC **REF** A600185U

QTY/PACK: 12

MATERIAL

Latex/Inox.

COLOURS

Metal/Skin.

Other colours on request.



NEW **REF** A600271U

QTY/PACK: 12

MATERIAL

Polypropylene/Silicone.

COLOURS

Clear/Blue.

Other colours on request.



CLEAR **REF** A600371U

QTY/PACK: 12

MATERIAL

Polycarbonate.

COLOURS

Clear blue.

Other colours on request.



PACKAGING
BOX/LEAFLET
CUSTOMISABLE

INNER BOX: 12 PCS

EAR PROTECTION

Wearing earplugs for swimming helps prevent water from entering the ears, reducing the risk of infections and discomfort, and allows for better focus while swimming without distractions.

RESINTEX REF A700197U

QTY/PACK: 12
(3 PCS PER COLOUR)

MATERIAL

Resintex.

COLOURS

Assorted colours.



ARROW REF A700272U

QTY/PACK: 12

MATERIAL

100% Silicone.

COLOURS

Red.

Other colours on request.



SHELL REF A600371U

QTY/PACK: 12

MATERIAL

100% Silicone.

COLOURS

Royal blue.

Other colours on request.



PACKAGING
BOX/LEAFLET

INNER BOX: 12 PCS

CUSTOMISABLE

SLIDE SILICONE FINN

Shorter blade improves kicking mechanics and efficiency.
Flexible foot pocket and closed ankle provides extra support.



71 ROYAL BLUE

SLIDE REF **A802172**

EU SIZES

32-33
34-35
35-36
37-38
39-40
41-42
43-44
45-46

MATERIAL

100% Silicone.

CUSTOMISABLE

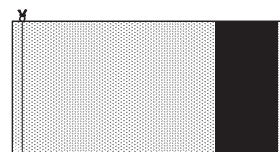

PACKAGING
MESH BAG



EXPORT CARTON: 10 PAIRS

RECYCLED SILICONE FINN

Silicone fins made from 30% recycled silicone.
Shorter blade improves kicking mechanics and efficiency.
Flexible foot pocket and closed ankle provides extra support.
Made from top quality recycled silicone for comfort and added durability.



Made from
**RECYCLED
SILICONE**



72 NAVY BLUE

RECYCLED FINN REF **A802071**

EU SIZES	LENGHT
33-34	220-225 mm
37-38	240-245 mm
43-44	270-275 mm
45-46	280-285 mm
47-48	290-295 mm

MATERIAL
100% Silicone, 30% RECYCLED.

CUSTOMISABLE



PACKAGING
MESH BAG

EXPORT CARTON: 10 PAIRS

BLACK SILICONE FINN

Shorter blade improves kicking mechanics and efficiency.
Flexible foot pocket and closed ankle provides extra support.
Made from top quality silicone rubber for comfort and added durability. Very comfortable fit.



90 BLACK

BLACK FINN REF A8001

EU SIZES	LENGHT
31-32	205-210 mm
33-34	220-225 mm
35-36	230-235 mm
37-38	240-245 mm
39-40	250-255 mm
41-42	260-265 mm
43-44	270-275 mm
45-46	280-285 mm
47-48	290-295 mm

MATERIAL

100% Silicone.

CUSTOMISABLE

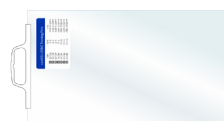

PACKAGING

HANGER BAG

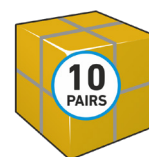

EXPORT CARTON: 10 PAIRS

COLOURFUL SILICONE FINN

Shorter blade improves kicking mechanics and efficiency.
Flexible foot pocket and closed ankle provides extra support.
Made from top quality silicone rubber for comfort and added durability. Very comfortable fit.



SIZE: 31-32
COLOUR: FLUOR
YELLOW



SIZE: 39-40
COLOUR: RED



SIZE: 33-34
COLOUR: LIGHT
BLUE



SIZE: 41-42
COLOUR: ROYAL
BLUE



SIZE: 35-36
COLOUR: ORANGE



SIZE: 43-44
COLOUR: NAVY
BLUE



SIZE: 37-38
COLOUR: FLUOR
GREEN



SIZE: 45-46
COLOUR: DARK
GREY

COLOURFUL FINN REF **A8002**

EU SIZES	LENGHT
31-32	205-210 mm
33-34	220-225 mm
35-36	230-235 mm
37-38	240-245 mm
39-40	250-255 mm
41-42	260-265 mm
43-44	270-275 mm
45-46	280-285 mm

MATERIAL
100% Silicone.

CUSTOMISABLE



PACKAGING
HANGER BAG



EXPORT CARTON: 10 PAIRS

OPEN FINS

Open fins enhance kicking technique by allowing better water flow, strengthening leg and core muscles to boost power and speed. They help maintain body alignment, reduce ankle strain, and promote natural movement, making them ideal for long training sessions.



90/40 BLACK/RED

OPEN FINS REF **A8013**

EU SIZES

XS 35-38
S 38-40
M 40-43
L 43-45
XL 45-47

MATERIAL

100% Silicone.

CUSTOMISABLE



PACKAGING
MESH BAG



EXPORT CARTON: 10 PAIRS

FIN PRO

The new FIN PRO fins are versatile short training fins, thanks to their two removable front pieces. For intensive training, the orange reinforcement pieces add water resistance and more push, while for a lighter workout, the pieces can be removed.

NEW



SIZE: 36-38
YELLOW



SIZE: 39-40
ORANGE



SIZE: 41-43
GREEN



SIZE: 44-45
SKY BLUE



SIZE: 46-47
NAVY BLUE



FIN PRO REF A8015

EU SIZES

- S 36-38
- M 39-40
- ML 41-43
- L 44-45
- XL 46-47

MATERIAL

Silicone + ABS.

CUSTOMISABLE



PACKAGING
MESH BAG



EXPORT CARTON: 10 PAIRS

FRONTAL SNORKELS

Frontal snorkel ensures smooth arm rotation, maintain body alignment and improve stroke efficiency.

The swimming snorkel allows smooth airflow and provides healthy amounts of oxygen whilst lap swimming, triathlon to maximize speed.

Thickened head-pad sits firmly on head front, delivering comfort and eliminating movement when flip turns all four strokes.

Durable food-grade and odorless mouth piece, fits perfectly in the mouth and keep the snorkel in place. One-way purge helps to drain the water entirely during exhalation.

Sleek hydrodynamic design allows swimmers to swim effortlessly with minimal water resistance.



JUNIOR



ADULT



JUNIOR REF **A1300121JR**

ADULT REF **A1300172SR**

TUBE

PVC.

MOUTHPIECE/STRAP

Liquid silicone.

BOTTOM CAP

PC.

KEEPER

POM (Polyoxymethylene).

ANTI SPLASH (adult)

TPE.

CUSTOMISABLE

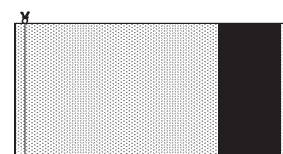

PACKAGING

MESH BAG

DIVING SETS

This dive set includes goggles, snorkel, and fins, ideal for snorkeling and underwater exploration. This set is ideal for beginners.



JUNIOR



ADULT

DIVING SET REF **A1301671U**

MASK

Polycarbonate lenses.
PVC gasket.

SNORKEL

Soft PVC.

FINS

Very comfortable.
PP BLADE structure flexible and resistant.
Soft TPR foot pocket.
Easily adjustable PVC strap.

PACKS

SIZE	UNITS
28-31	1
32-35	4
38-42	5
43-46	2



PACKAGING
MESH BAG

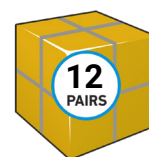

EXPORT CARTON: 12 PAIRS

TRAINING HAND PADDLES

Hand paddles build strength and endurance by adding resistance, improving stroke technique, body alignment, and water feel, while increasing speed. They're ideal for swimmers looking to enhance strength, technique, and control in each stroke.

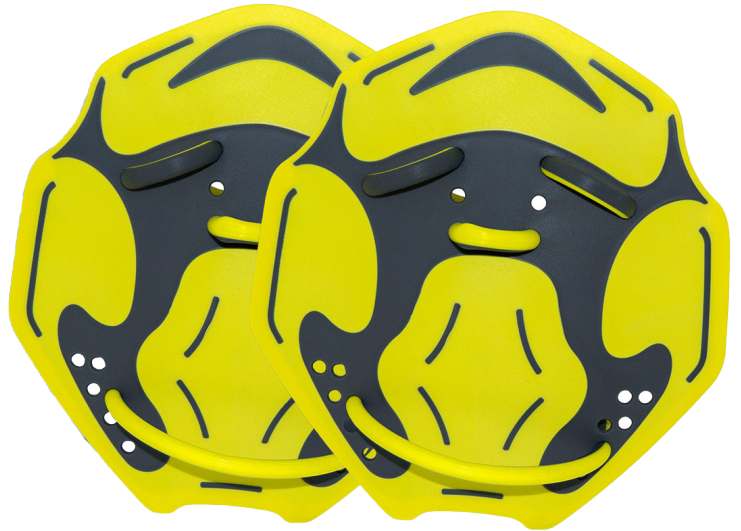

FOIL REF **A9003**

COLOUR
Yellow/Grey

SIZE L
23x26 cm.

CUSTOMISABLE

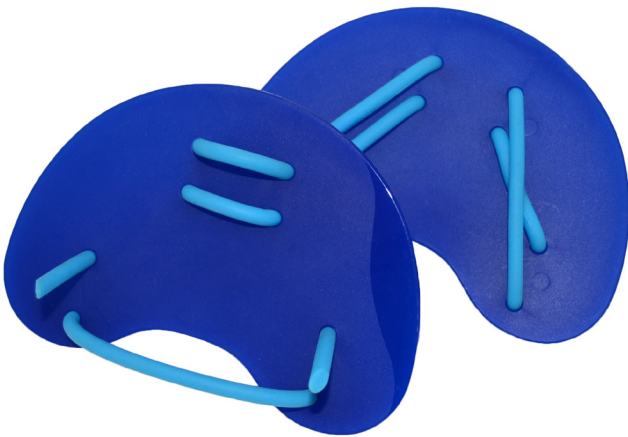

MOON REF **A9005**

MATERIAL
PE blades and silicone finger straps.
2 separate finger straps for custom adjustment.

SIZE
15 x 8,5 cm.

CUSTOMISABLE



PACKAGING
NEUTRAL POLYBAG

TEAM HAND PADDLES

Hand paddles build strength and endurance by adding resistance, improving stroke technique, body alignment, and water feel, while increasing speed. They're ideal for swimmers looking to enhance strength, technique, and control in each stroke.



TEAM **REF** A9001

MATERIAL

PE blades and silicone finger straps.

SIZE

S 17x14 cm - red straps.

M 21x18 cm - orange straps.

L 24x21 cm - blue straps.

CUSTOMISABLE

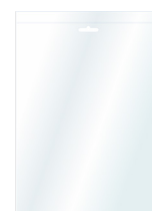

PACKAGING

NEUTRAL POLYBAG

POOL BAGS

MESH BAG REF A11009

MATERIAL

100% Nylon fabric.

SIZE

70x50 cm.

CUSTOMISABLE



90 BLACK



49 FLUOR PINK

DRAWCORD BAG REF A11008

MATERIAL

100% Polyester (210D) with PU reinforcement.

SIZE

44x34 cm.

CUSTOMISABLE

Custom print area: 32x26 cm.



AVAILABLE Colours

- | | | | | |
|----------|------------|--------------|----------|-------------|
| ○ WHITE | ● GREEN | ● BORDEAUX | ● VIOLET | ● SILVER |
| ● YELLOW | ● SKY BLUE | ● PINK | ● ROYAL | ● DARK GREY |
| ● LIME | ● ORANGE | ● FLUOR PINK | ● NAVY | ● BLACK |
| ● LAGOON | ● RED | | | |

POOL BAGS REF A11017

MATERIAL

100% Polyester / PU + Mesh.

SIZE

62x45 cm.

CUSTOMISABLE



71 ROYAL BLUE



90 BLACK

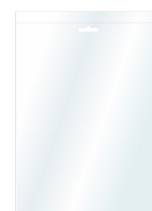

PACKAGING

NEUTRAL POLYBAG

BACKPACKS

TRAINA REF **A11002**

MATERIAL

100% High density polyester.

CAPACITY

26L.

SIZE

43x30x24 cm.

CUSTOMISABLE



90 BLACK



90 BLACK

TROTMAN REF **A11003**

MATERIAL

100% High density polyester.

CAPACITY

38L.

SIZE

48x33x25 cm.

CUSTOMISABLE

ALLTREK REF **A11050**

MATERIAL

100% High density polyester.

CAPACITY

45L.

SIZE

51x34x27 cm.

CUSTOMISABLE



90 BLACK

TRAINING BAG REF **A11039**

MATERIAL

EVA, polyester and PU coating.

CAPACITY

24L.

SIZE

55x30x32 cm.

CUSTOMISABLE



90/61 BLACK/GREEN



PACKAGING

NEUTRAL POLYBAG

DRY BAGS

A dry bag keeps belongings dry during outdoor activities like kayaking or hiking. Its lightweight, compact design and adjustable straps allow easy transport as a backpack or by hand. Ideal for storing clothes, electronics, and water-sensitive items on adventures.



70 SKY BLUE

30 ORANGE



62 FLUOR GREEN

70 SKY BLUE

SMALL REF A11027

Waterproof floating bag.

MATERIAL

500D PVC + Tarpaulin.

CAPACITY

2L.

CUSTOMISABLE

BIG REF A11028

Waterproof floating bag.

MATERIAL

500D PVC + Tarpaulin.

CAPACITY

15L.

CUSTOMISABLE

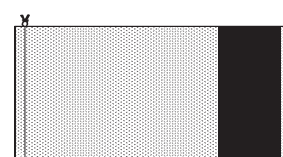

PACKAGING

MESH BAG

INFLATABLE SWIM BUOYS



This buoy allows you to store items inside it before inflating, keeping them dry while you swim.



30 ORANGE



30 ORANGE



20 FLUOR YELLOW

PRO SWIM BUOY REF A10030

Buoyancy: Max. 18kg.

Capacity: 28L.

This bag is suitable for open water swimming and water sports.

Material: Nylon + environmentally friendly PVC.

CUSTOMISABLE

INFLATABLE SWIM BUOY REF A10020

Buoyancy: Max. 8kg.

Equipped with a large valve to inflate quickly using the mouth to blow. The Swim Buoy is lightweight, there is no sense of restraint when swimming, does not affect the swimming action and speed.

CUSTOMISABLE

PACKAGING

NEUTRAL POLYBAG

TRAINING MATERIAL: BOARDS

Swimming boards improve kicking technique, build leg strength, and help isolate the lower body, allowing swimmers to focus on their form and enhance training effectiveness.



EUROKICK REF → A10002711U

SIZE

47x28x3 cm



BIG BOARD REF → A100037110L

SIZE

47x28x3 cm



MEDIUM BOARD REF → A100037110M

SIZE

38x23x3 cm



BIG BOARD REF → A100037110S

SIZE

29x22x3 cm

BOARDS

MATERIAL

Eva foam.

COLOUR

Blue / White.

CUSTOMISABLE

Can be customised by heat embossing or printing.
Other colours under request.

TRAINING MATERIAL: PULL BUOY

Pull buoys are used to improve upper body strength by isolating the legs, allowing swimmers to focus on arm strokes. They help maintain proper body position and alignment in the water, enhancing technique and endurance during swim training.



BICOLOUR REF → A100047110U

SIZE

24x13x8 cm

7110 BLUE / WHITE

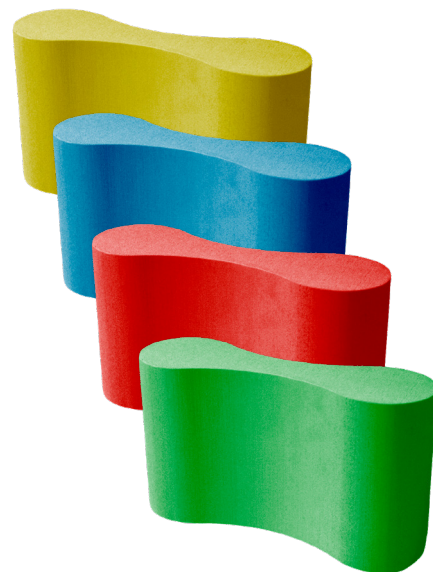

MONOCOLOUR REF → A10004

SIZE

23x10x8 cm

- 71 BLUE
- 21 YELLOW
- 61 GREEN
- 40 RED

PULL BUOY

MATERIAL

Eva foam.

CUSTOMISABLE

Can be customised by heat embossing or printing.
Other colours under request.

SUBLIMATED SWIMWEAR

Swim Beyond Limits. Swim Sublimated.

Ever wondered how we achieve those eye-popping, fade-resistant designs? Enter sublimation, a cutting-edge process that transforms ink into a gas, fusing it directly into the fabric. This isn't just printing – it's a molecular marriage between color and fabric. The result? Unparalleled brilliance that won't fade, crack, or peel.

Using European fabric such as Carvico Eco Sydney and Miti Speedline we personalize your aquatic journey with our customizable designs. From bold patterns to team logos, express yourself in the water like never before. Your swimwear, your style – because champions don't blend in, they stand out.

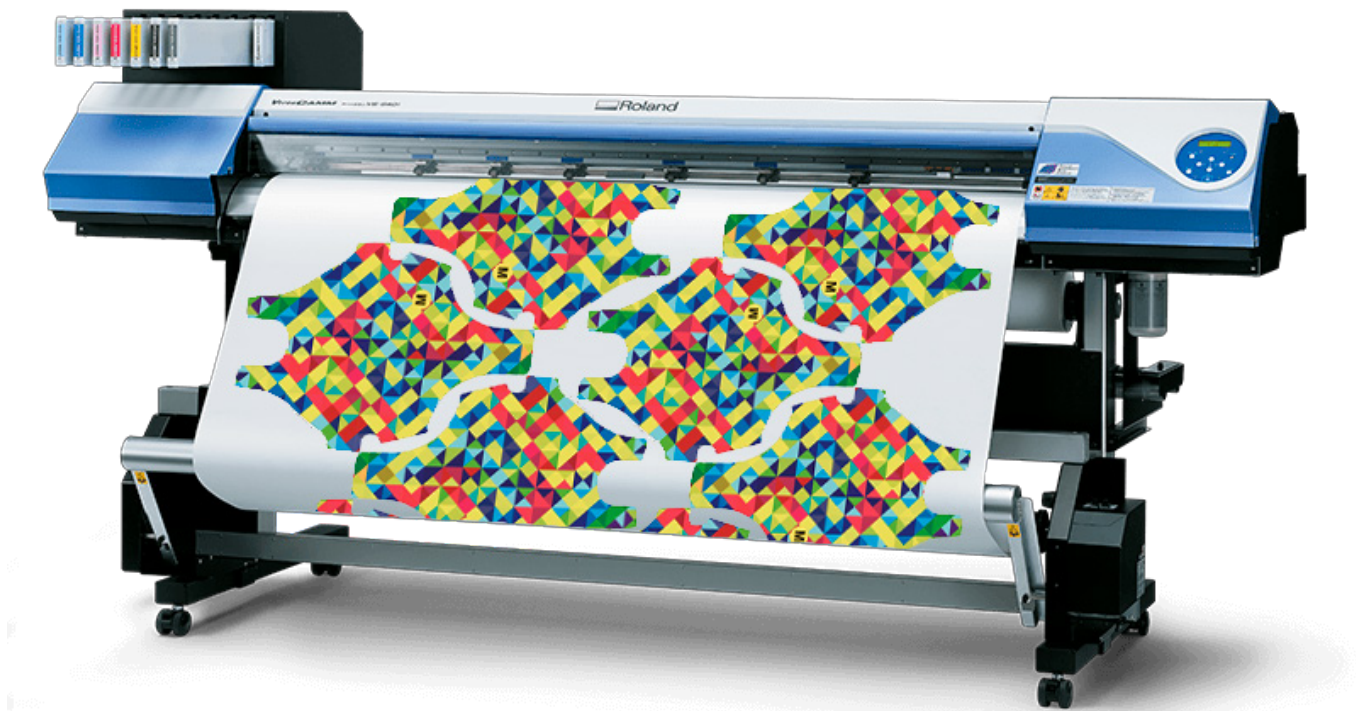

SUBLIMATION PROCESS



SHARE YOUR IDEAS WITH US
AND WE WILL START
BRAINSTORMING FOR YOU.

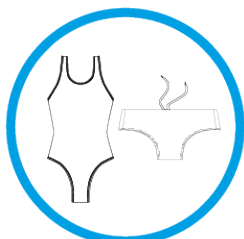

CHOOSE YOUR PATTERN



OUR DESIGNERS WILL ANALYZE
YOUR IDEAS AND PRESENT YOU
SEVERAL PROPOSALS.



IN ONLY 6 WEEKS THE
PRODUCTION WILL BE READY
FOR YOU TO ENJOY.



**CUSTOMISATION
IN SHORT SERIES**



**DIFFERENT
PATTERNS
AVAILABLE**

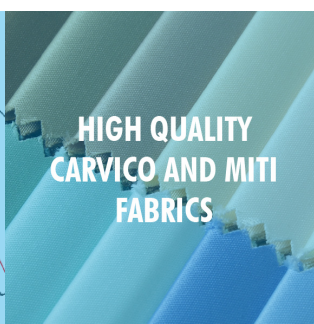

**HIGH QUALITY
CARVICO AND MITI
FABRICS**

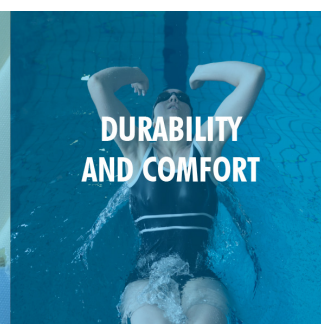

**DURABILITY
AND COMFORT**



SHORT DELIVERY TIMES AND COMPETITIVE PRICES

PATTERNS: WOMAN & GIRL

BROAD STRAP

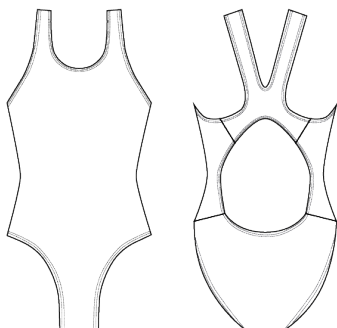

THIN STRAP

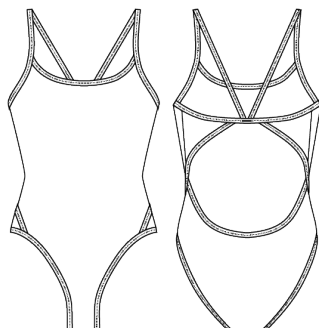

SEAMLESS

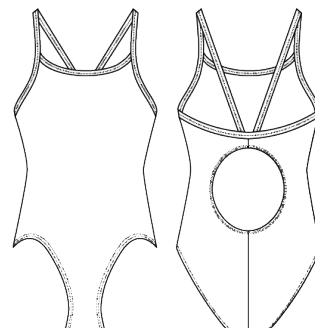

TIE BACK

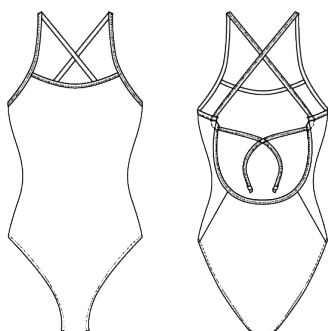

TRAINING BACK

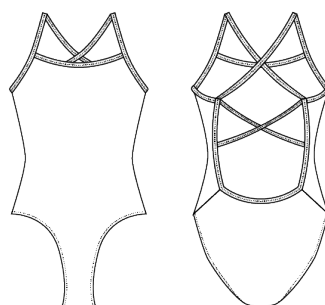

LUNA BACK

- Invisible seams -

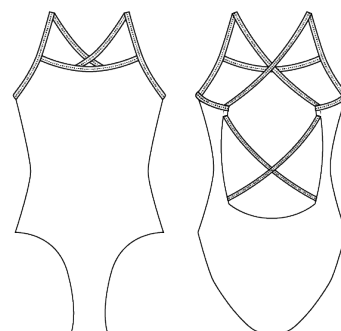

BIKINI

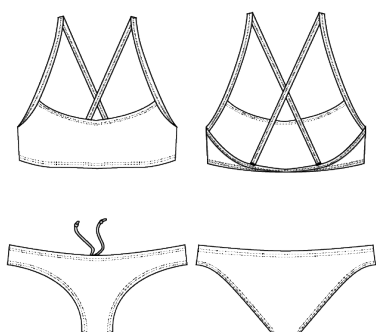

KNEESUIT

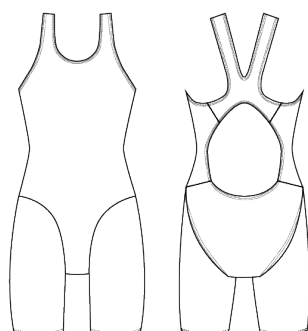

PATTERNS WOMAN AND GIRL

AVAILABLE MATERIAL

Sublimated: Sydney Eco (51% PI recycled, 49% PBT), Revolutionary Eco (79% Pa micro recycled, 21% Ea)-
Solid colours: Sydney Eco (51% PI recycled, 49% PBT), Malaga (80% Pa, 20% Ea), Morea (80% Pa, 20% Ea).

LINING

100% Polyamide with anti-chlorine treatment.

CUSTOMISABLE

PATTERNS: MAN & BOY

SLIP 5 CM

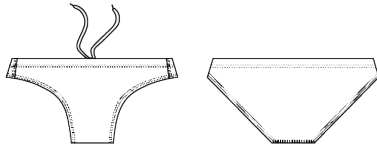

SLIP 8 CM

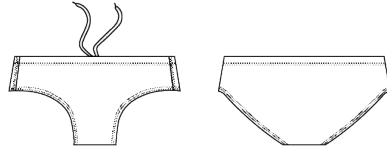

SLIP 12 CM

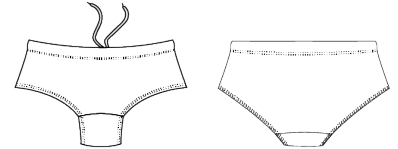

TRUNK 15 CM

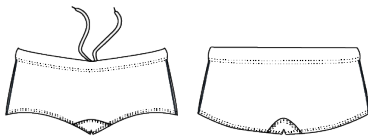

SHORTY BOY 23 CM
SHORTY MAN 29 CM

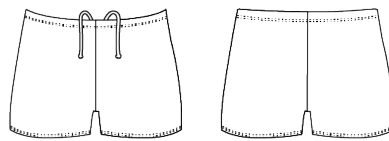

JAMMER

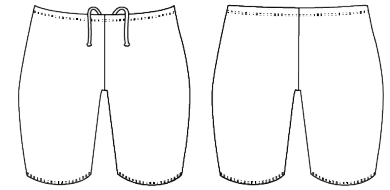

NEW SHORT IBIZA

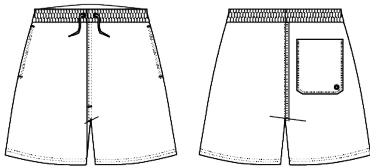

PATTERNS MAN AND BOY

AVAILABLE MATERIAL

Sublimated: Sydney Eco (51% PI recycled, 49% PBT), Revolutionary Eco (79% Pa micro recycled, 21% Ea)-
Solid colours: Sydney Eco (51% PI recycled, 49% PBT), Malaga (80% Pa, 20% Ea), Morea (80% Pa, 20% Ea).
Short Ibiza: Storm water repelent (100% PI).

LINING

100% Polyamide with anti-chlorine treatment.

CUSTOMISABLE

PATTERNS: WATERPOLO

WATERPOLO TRAINING

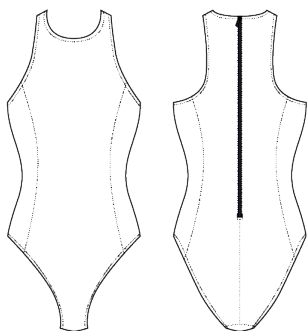

WATERPOLO COMPETITION

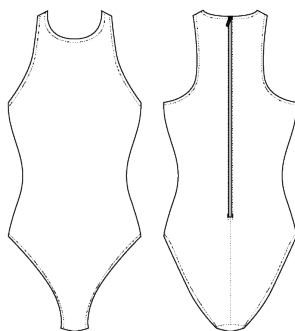

BRIEF 8 CM COMPETITION

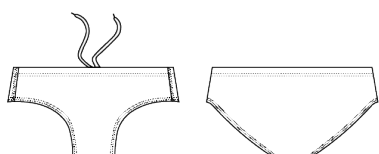

WATERPOLO CAP

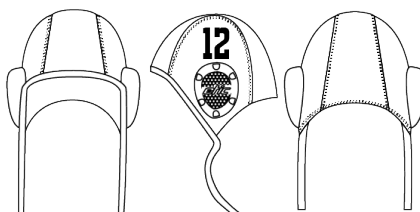

WATERPOLO

AVAILABLE MATERIAL

Sublimated: Speedline (100% PI).

Solid colours: Speedline (100% PI).

LINING

Speedline (100% PI).

CUSTOMISABLE

PATTERNS: CAP & TOWEL

SUBLIMATED CAP

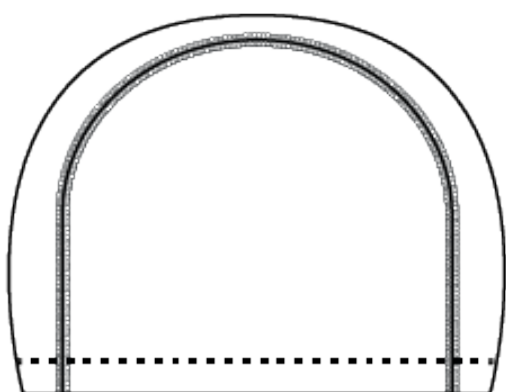

SUBLIMATED CAP

MATERIAL

Vita (78% Pa recycled, 22% Ea).

SIZE

JUNIOR: 18 x 17,5 cm. Band: 45 x 8,5 cm.

ADULT: 20 x 19 cm. Band: 48 x 9 cm.

CUSTOMISABLE

SUBLIMATED TOWEL

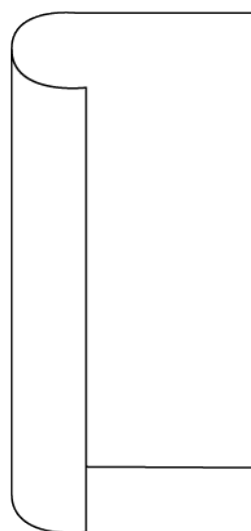

MICROFIBRE SUBLIMATED TOWEL

MATERIAL

88% Polyester / 12% Polyamide.

SIZE

80 x 150 cm.

CUSTOMISABLE

Customisable one or two sizes.



VELVET SUBLIMATED TOWEL

MATERIAL

80% Polyester / 20% Polyamide.

SIZE

75 x 150 cm.

50 x 100 cm.

40 x 80 cm.

CUSTOMISABLE

Customisable one or two sizes.

PONCHO, SURF & SUN TOP

PONCHO KIDS

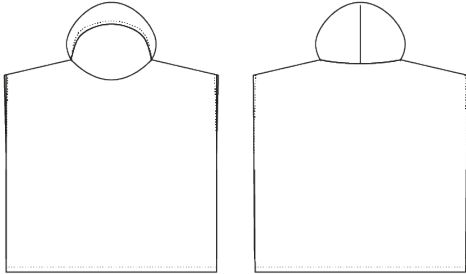

SURF SWIMSUIT

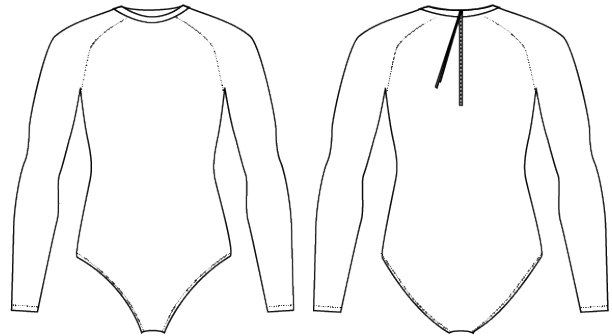

PONCHO JR/SR

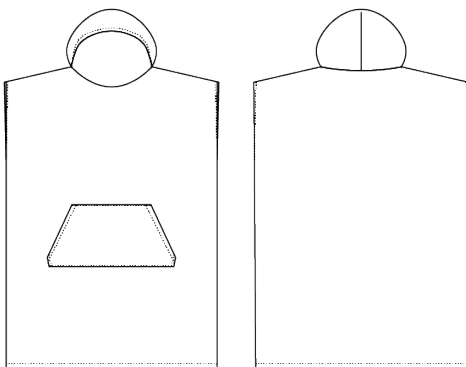

SUN PROTECTION TOP

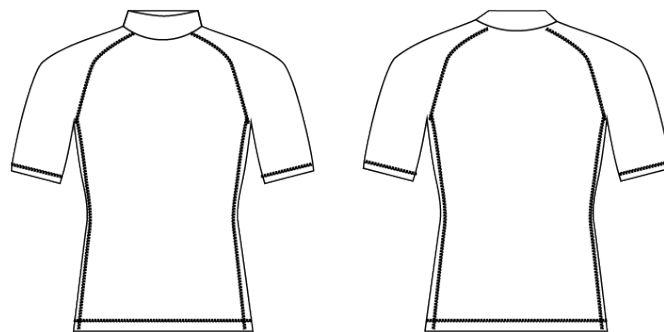

PONCHO

MATERIAL

80% Polyester / 20% Polyamide.

SIZE

Kids.

JR & SR.

CUSTOMISABLE

SURF AND SUN PROTECTION TOP

AVAILABLE MATERIAL

Sublimated: Vita (78% Pa recycled, 22% Ea).

Solid colours: Sydney Eco (51% PI recycled, 49% PBT).

CUSTOMISABLE

BINDING, LINING & SOLIDS

BINDING COLOURS AVAILABLE

80% Polyamide / 20% Elastane.

STANDARD COLOURS



FLUOR COLOURS

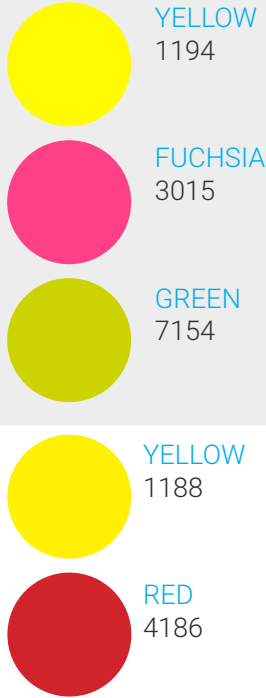

LINING COLOURS AVAILABLE

100% Polyamide.

STANDARD COLOURS



SYDNEY ECO AVAILABLE COLOURS

51% PI recycled, 49% PBT.

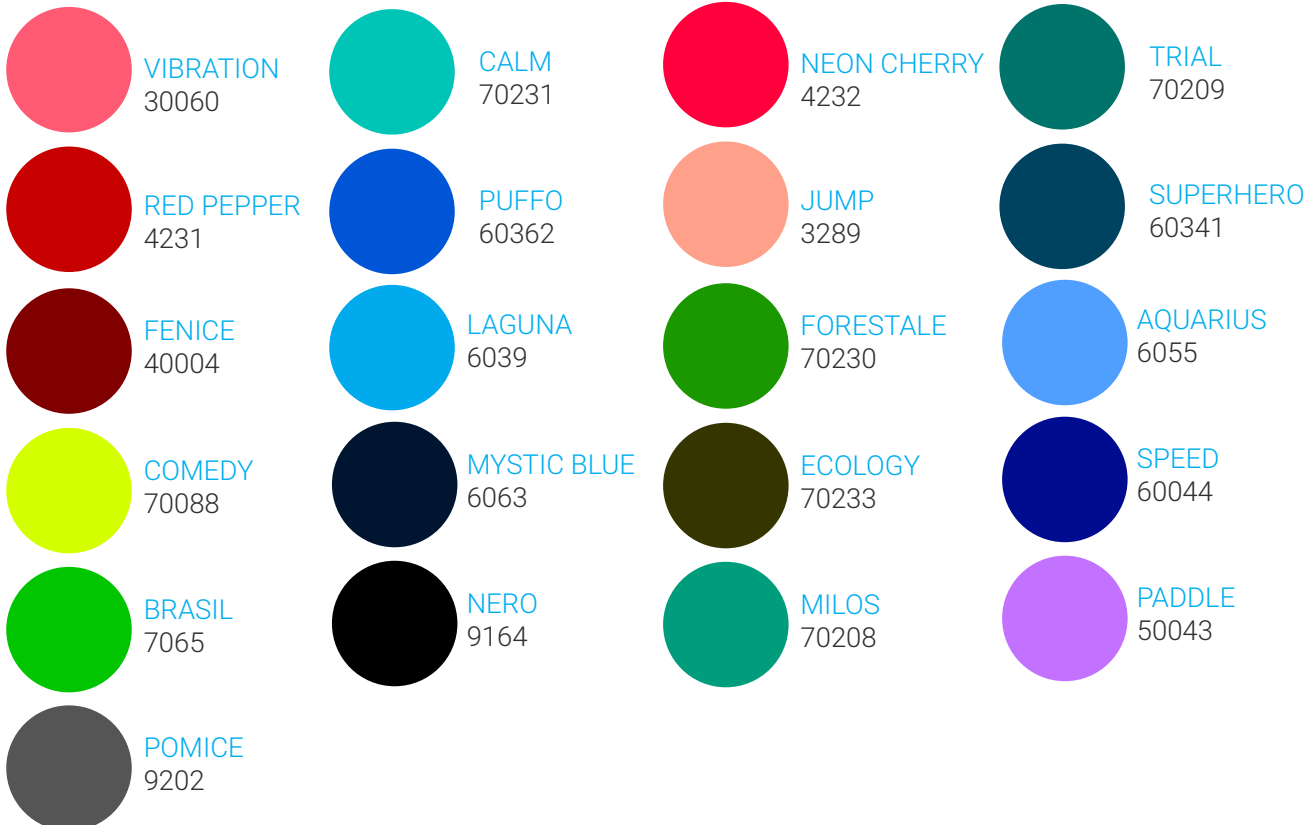

SIZE GUIDE

BODY MEASUREMENTS FOR MEN SUBLIMATED SUITS (CM)

	XS	S	M	L	XL	2XL
HIP	82	86	90	94	98	102

BODY MEASUREMENTS FOR WOMEN SUBLIMATED SUITS (CM)

	XS	S	M	L	XL	2XL
CHEST	78	82	86	90	94	98
WAIST	58	62	66	70	74	78
HIP	78	82	86	90	94	98

BODY MEASUREMENTS FOR BOY SUBLIMATED SUITS (CM)

	4	6	8	10	12	14
HIP	62	66	70	74	78	82

BODY MEASUREMENTS FOR GIRL SUBLIMATED SUITS (CM)

	4	6	8	10	12	14
CHEST	52	58	62	66	70	74
WAIST	40	44	48	52	56	60
HIP	56	60	64	68	72	76

COUNTRY SIZE TABLE

WOMAN	XS	S	M	L	XL	2XL
ES	34	36	38	40	42	44
ITA	38	40	42	44	46	48
FR	36	38	40	42	44	46
D	32	34	36	38	40	42
UK/USA	28	30	32	34	36	38

MAN	XS	S	M	L	XL	2XL
------------	-----------	----------	----------	----------	-----------	------------

JUNIOR	AVAILABLE SIZES					
AGE	4	6	8	10	12	14

SUBLIMATED TEAM LINE

SUBLIMATED T-SHIRT



COMPOSITION
100% polyester

SIZES
Adult: S, M, L, XL, 2XL, 3XL
Kids: 4, 6, 8, 10, 12, 14, 16 YEARS

SUBLIMATED POLO SHIRT



COMPOSITION
100% polyester

SIZES
Adult: S, M, L, XL, 2XL, 3XL
Kids: 4, 6, 8, 10, 12, 14, 16 YEARS

SUBLIMATED SWEATSHIRTS



COMPOSITION
100% polyester

SIZES
Adult: S, M, L, XL, 2XL, 3XL
Kids: 4, 6, 8, 10, 12, 14, 16 YEARS

SUBLIMATED TEAM LINE

SUBLIMATED SHORTS



COMPOSITION
100% polyester

SIZES
Adult: S, M, L, XL, 2XL, 3XL
Kids: 4, 6, 8, 10, 12, 14, 16 YEARS

SUBLIMATED PANTS



COMPOSITION
100% polyester

SIZES
Adult: S, M, L, XL, 2XL, 3XL
Kids: 4, 6, 8, 10, 12, 14, 16 YEARS

TEAM LINE: T-SHIRTS

COTTON SHORT-SLEEVED T-SHIRT



COMPOSITION

100% cotton, smooth point , 155 g/m²

SIZES

Adult: S, M, L, XL, 2XL, 3XL, 4XL

Kids: 1/2, 3/4, 5/6, 7/8, 9/10, 11/12 YEARS

POLYESTER SHORT-SLEEVED T-SHIRT



COMPOSITION

100% polyester pique , 150 g/m²

SIZES

Adult: S, M, L, XL, 2XL, 3XL, 4XL

Kids: 4, 8, 12, 16 YEARS

TEAM LINE: POLO SHIRTS

COTTON SHORT-SLEEVED POLO SHIRT



COMPOSITION

65% polyester, 35% cotton,
pique point. 190 g/m².

SIZES

Adult: S, M, L, XL, 2XL, 3XL, 4XL

Kids: 1/2, 3/4, 5/6, 7/8, 9/10, 11/12 YEARS

POLYESTER SHORT-SLEEVED POLO SHIRT



COMPOSITION

100% polyester, pique point. 150 g/m².

SIZES

Adult: S, M, L, XL, 2XL, 3XL

Kids: 1/2, 3/4, 5/6, 7/8, 9/10, 11/12, 13/14 YEARS

TEAM LINE: SWEATSHIRTS/JACKETS

SWEATSHIRTS



COMPOSITION

50% cotton / 50% polyester, brushed fleece ,
280 g/m².

SIZES

Adult: S, M, L, XL, 2XL, 3XL

Kids: 3/4, 5/6, 7/8, 9/10, 11/12 YEARS

JACKETS



COMPOSITION

Exterior: 100% polyester, 300T. Lining: 100% polyester.
Wadding: 100% polyester, feather effect. , 290 g/m²

SIZES

Adult: S, M, L, XL, 2XL, 3XL

Kids: 4, 6, 8, 10, 12, 14, 16 YEARS

TEAM LINE: PANTS

MONTREAL SHORTS



COMPOSITION

100% Polyester, 100 grs. Lining: 100 polyester

SIZES

Adult: S, M, L, XL, 2XL, 3XL, 4XL

Kids: 4, 6, 8, 10, 12, 14, 16 YEARS

SHORTS



COMPOSITION

60% cotton/ 40% polyester, non-brushed plush, 290 g/m².

SIZES

Adult: S, M, L, XL, 2XL

PANTS



COMPOSITION

60% cotton / 40% polyester, non-brushed plush, 280 g/m².

SIZES

Adult: S, M, L, XL, 2XL

Kids: 1/2, 3/4, 5/6, 7/8, 9/10, 11/12 YEARS

Delivery Service

Our lead times are key to our success. We offer delivery plans that will adapt to your needs.

Swim Caps

From the standard two-week and urgent deliveries in one-week time to our Express Service that will deliver your goods in 48 hours since order confirmation EXW Barcelona. MOQ is 50 pieces.

<p>STANDARD SERVICE</p> <hr/> <p>2 WEEKS BEST VALUE</p>	<p>URGENT SERVICE</p> <hr/> <p>1 WEEK FAST SERVICE</p>	<p>EXPRESS SERVICE</p> <hr/> <p>48 HOURS FASTEST SERVICE</p>
--	---	---

Sublimated Swimwear

<p>TUNISIA SERVICE</p> <hr/> <p>6 WEEKS BEST VALUE</p>	<p>BARCELONA SERVICE</p> <hr/> <p>4 WEEKS FAST SERVICE</p>	<p>EXPRESS SERVICE</p> <hr/> <p>GET IN TOUCH WITH US</p>
---	---	--

Ask us about the rest of our customised products. Since we use a different process for each kind of material, the printing and delivery time can change between products.





Comercial Group SA

Calle Berguedà 4, Nave 1

08130 Sta Perpetua de Mogoda, Barcelona

+34 93 574 99 00

export@comercialgroup.com